

NOZZLE SCHEDULE			
MARK	QTY	SIZE / RATING	DESCRIPTION
N1	1	6" RFSO CL150	INLET
N2	1	6" RFSO CL150	OUTLET
N3	2	1/2" NPT CL3000	PRESSURE GAUGE
N4	1	1/2" NPT CL3000	VENT
N5	1	2" NPT CL3000	CLEAN DRAIN
N6	1	1/2" NPT CL3000	DIRTY DRAIN

VESSEL DESIGN CONDITIONS	
CODE: ASME SECTION VIII DIV. 1, 2019 EDITION	
M.A.W.P.: 150 PSI @ 400°F	M.D.M.T.: -20°F @ 150 PSI
M.A.W.P.: FV PSI @ 400°F	HYDROTEST PRESS: 210 PSI
CORROSION ALLOWANCE: N/A	SERVICE: UNK. LIQUID, NON-LETHAL
STAMP: U	RADIOGRAPHY: N/A
PWHT: N/A	GASKET: <input type="checkbox"/> BUNA <input type="checkbox"/> VITON <input type="checkbox"/> EPDM
MATERIAL: SS316	<input type="checkbox"/> OTHER: _____
NOTES: DRY WEIGHT: 540 LBS SHIPPING WEIGHT: 600 LBS VOLUME: 10.75 CU. FT. INTERNALS: 6x SIZE 2 BASKETS (SS316)	FACTORY INSTALLED OPTIONS: <input type="checkbox"/> STAINLESS STEEL BOLTING (SS316) <input type="checkbox"/> MESH LINED BASKETS: _____ MESH <input type="checkbox"/> N3 DIFFERENTIAL PRESSURE GAUGE TYPE: _____ <input type="checkbox"/> N4 PRESSURE RELIEF VALVE TYPE: _____ <input type="checkbox"/> N4 AIR ELIMINATOR TYPE: _____ <input type="checkbox"/> N4 VENT VALVE <input type="checkbox"/> N5/N6 DRAIN VALVES

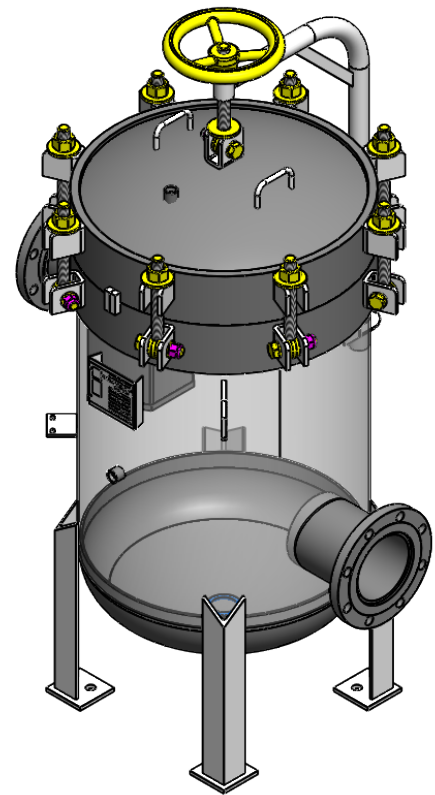

APPROVED WITH MARK-UPS APPROVED

 THIRD ANGLE PROJECTION TOLERANCES-UNLESS OTHERWISE NOTED DECIMAL .X = ±.1" .XX = ±.02" .XXX = ±.005" FRACTIONAL = ±1/8" ANGULAR = ± 1" MAX. MACHINED SURFACE FINISH 125/√	 FIL-TREK CORPORATION 55 Stafford Court Cambridge, Ontario N1T 1B3 Canada Phone: (519) 623-7448 Fax: (519) 623-8807 Email: info@fil-trek.com Website: www.fil-trek.com				
	THIS DRAWING IS THE PROPERTY OF 'FIL-TREK CORPORATION' AND MUST NOT BE COPIED OR USED IN ANY WAY DETRIMENTAL TO THE CORPORATION EQUIPMENT: LP SERIES (BAG FILTER VESSEL) MODEL NO: S6LP24-612-6F-A-150A CUSTOMER:				
VESSEL QUANTITY:	DRAWN: AJ	DATE: 2020-03-05	SERIAL No.	Part No. 002004-01113	REV. No. 0
	CHK'D: TS	SCALE: NTS			