

NOZZLE SCHEDULE			
MARK	QTY	SIZE / RATING	DESCRIPTION
N1	1	4" RFSO CL150	INLET
N2	1	4" RFSO CL150	OUTLET
N3	2	1/2" NPT CL3000	PRESSURE GAUGE
N4	1	1/2" NPT CL3000	VENT
N5	1	1/2" NPT CL3000	CLEAN DRAIN
N6	0		DIRTY DRAIN

VESSEL DESIGN CONDITIONS	
CODE: ASME SECTION VIII DIV. 1, 2019 EDITION	
M.A.W.P.: 150 PSI @ 400°F	M.D.M.T.: -20°F @ 150 PSI
M.A.W.P.: FV PSI @ 400°F	HYDROTEST PRESS: 195 PSI
CORROSION ALLOWANCE: N/A	SERVICE: UNK. LIQUID, NON-LETHAL
STAMP: UM	RADIOGRAPHY: N/A
PWHT: N/A	GASKET: <input type="checkbox"/> BUNA <input type="checkbox"/> VITON <input type="checkbox"/> EPDM
MATERIAL: SS304	<input type="checkbox"/> OTHER: _____
NOTES: DRY WEIGHT: 140 LBS SHIPPING WEIGHT: 170 LBS VOLUME: 0.75 CU. FT. INTERNALS: 1 X SIZE 1 BAKSET	
FACTORY INSTALLED OPTIONS: <input type="checkbox"/> STAINLESS STEEL BOLTING (SS316) <input type="checkbox"/> MESH LINED BASKETS: _____ MESH <input type="checkbox"/> N3 DIFFERENTIAL PRESSURE GAUGE TYPE: _____ <input type="checkbox"/> N4 PRESSURE RELIEF VALVE TYPE: _____ <input type="checkbox"/> N4 AIR ELIMINATOR TYPE: _____ <input type="checkbox"/> N4 VENT VALVE <input type="checkbox"/> N5/N6 DRAIN VALVES	

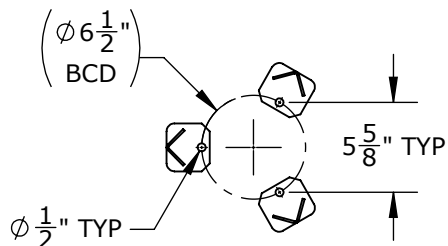
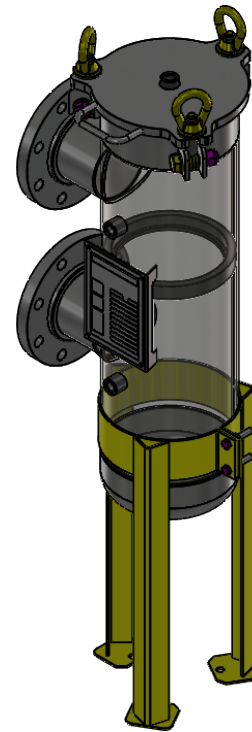
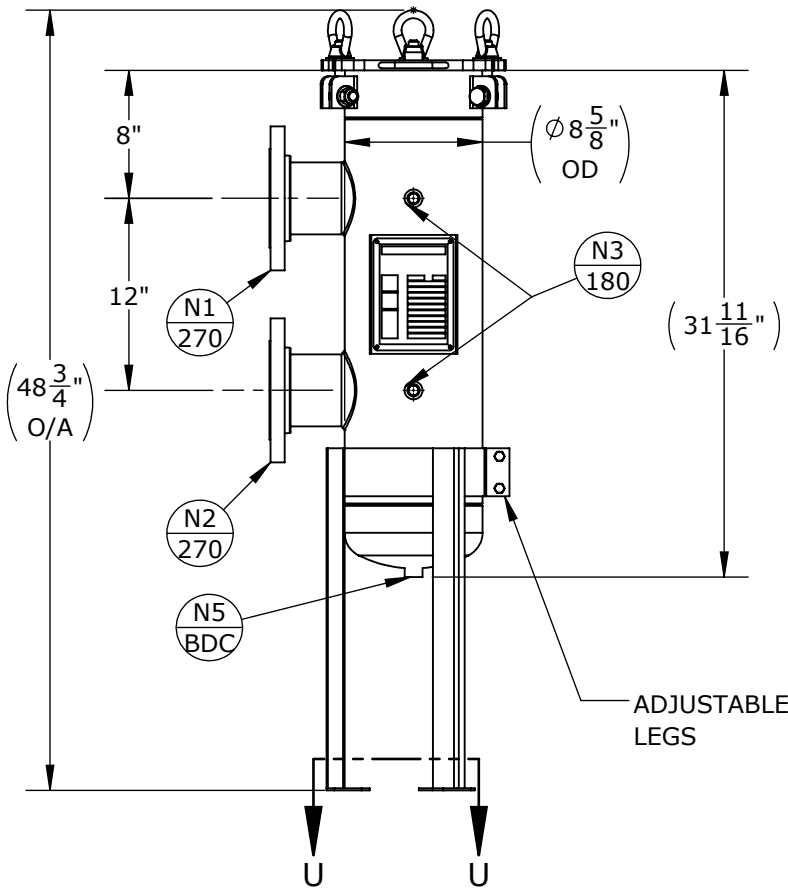

SECTION U-U
SCALE 1 : 12

APPROVED WITH MARK-UPS APPROVED

THIRD ANGLE PROJECTION
 TOLERANCES-UNLESS OTHERWISE NOTED
 DECIMAL .X = ±.1"
 .XX = ±.02"
 .XXX = ±.005"
 FRACTIONAL = ±1/8"
 ANGULAR = ± 1°
 MAX. MACHINED SURFACE FINISH 125/√

FIL-TREK CORPORATION
 55 Stafford Court
 Cambridge, Ontario
 N1T 1B3
 Canada
 Phone: (519) 623-7448
 Fax: (519) 623-8807
 Email: info@fil-trek.com
 Website: www.fil-trek.com

THIS DRAWING IS THE PROPERTY OF 'FIL-TREK CORPORATION' AND MUST NOT BE COPIED OR USED IN ANY WAY DETRIMENTAL TO THE CORPORATION

EQUIPMENT: SL SERIES (BAG FILTER HOUSING)
 MODEL NO: S4SL111-4F-DB-150
 CUSTOMER:

VESSEL QUANTITY:	DRAWN: CL	DATE: 2020-03-05	SERIAL No.	Part No. 002002-00659	REV. No. 0
	CHK'D: AJ	SCALE: NTS			